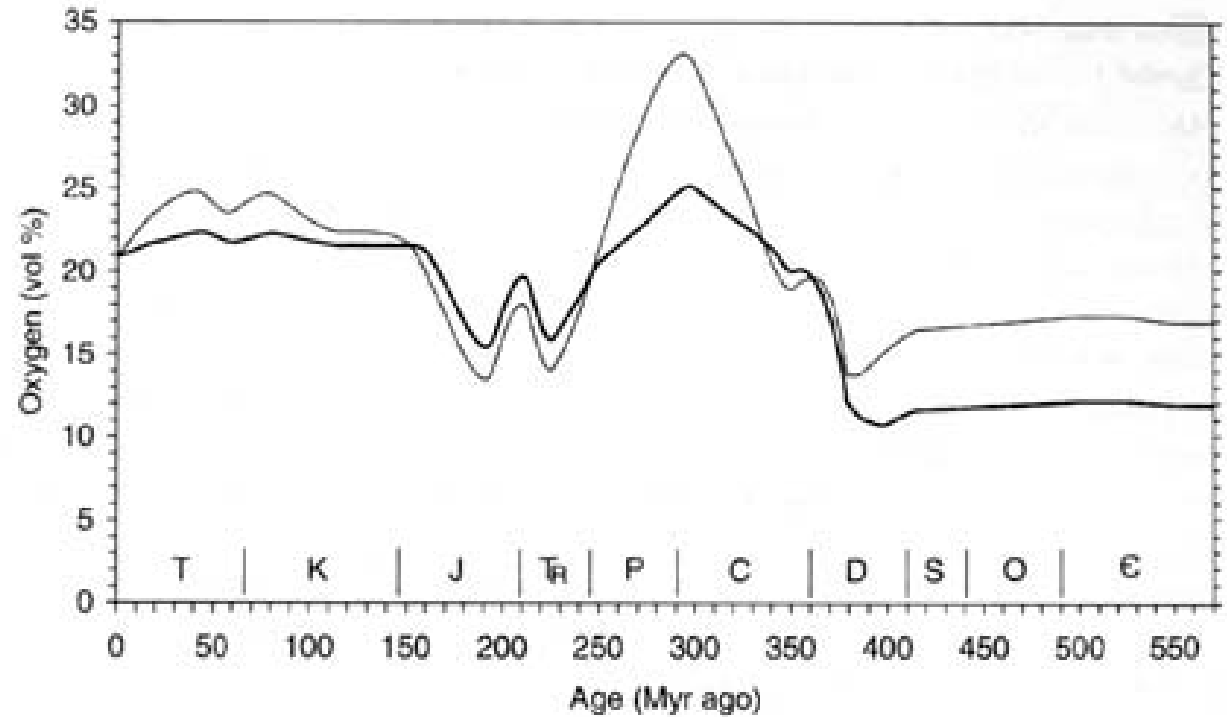

Fig. 4 Predicted atmospheric oxygen over Phanerozoic time (the last 570 Myr), based on Berner & Canfield's (1989) mass-balance model and forcing data. The faint line (control run) is an attempt to reproduce their results. The effect of plants on phosphorus weathering and resulting negative feedback on oxygen (Fig. 3) were then added to the model as described in the appendix. Plants are assumed to have begun to affect phosphorus weathering 400 Ma and to have doubled its rate by 360 Ma ($\alpha = 2$). From then on half of the phosphorus weathering flux is affected by vegetation. The bold line shows the revised oxygen predictions. The different geological periods are indicated: Cambrian (C), Ordovician (O), Silurian (S), Devonian (D), Carboniferous (C), Permian (P), Triassic (TR), Jurassic (J), Cretaceous (K), Tertiary (T).



Proterozoic (1.2 Ga): cyanobacteria, green algae?

Ordovician (450 Ma): embryophytes:

evidence of structural complexity (weathering rate), spores.

Silurian (420-400 Ma): embryophytes:

evidence of the tracheids, cuticle, stomata,

intercellular gas spaces, sporangia of vascular

plants: lycophytes, rhyniophytes.

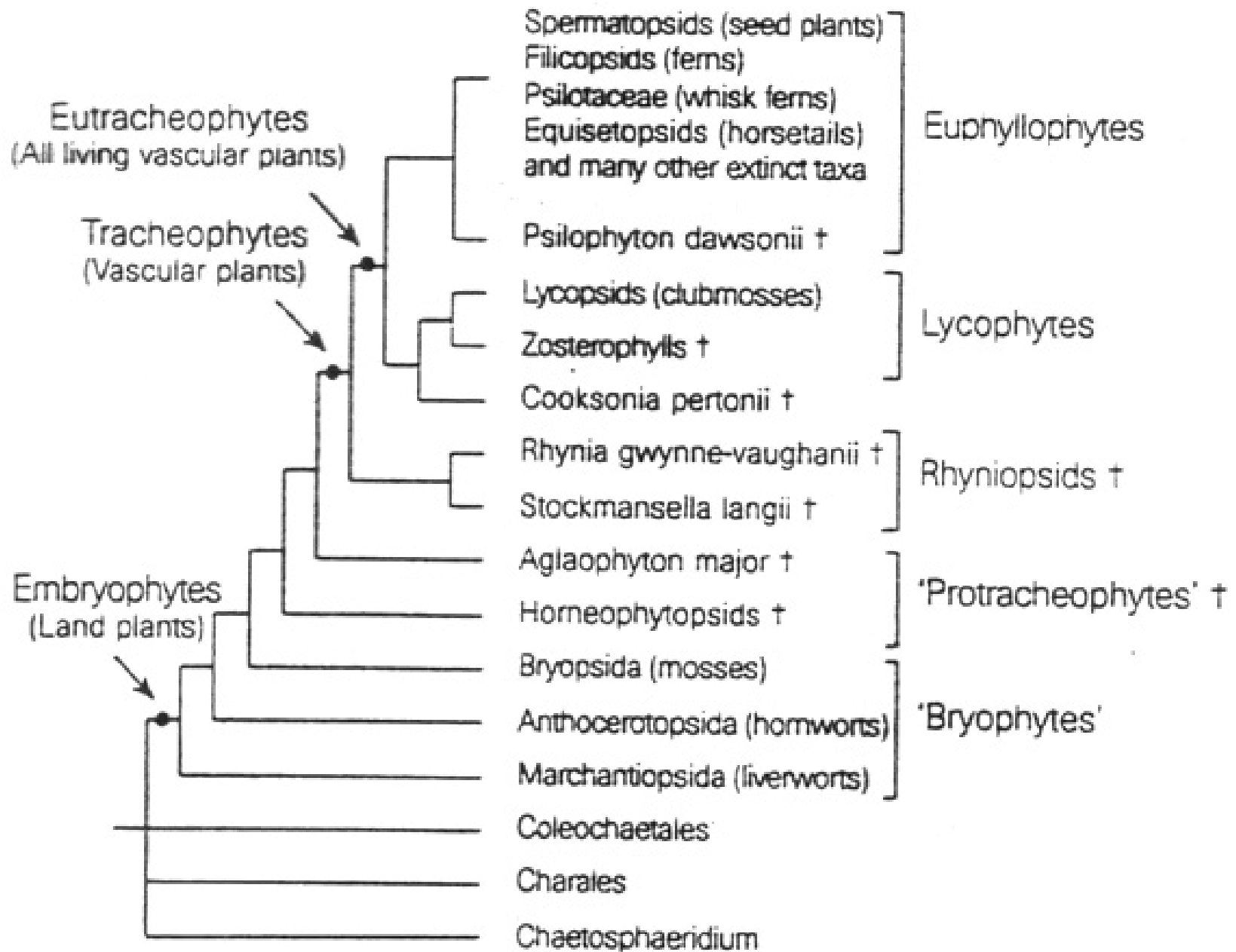

Devonian (Mid: 370 Ma)

Embryophytes: vascular plant sporophytes with secondary thickening (i.e. woody), up to 3 m tall, with ‘roots’ (or their equivalents) going 1 m into rock/soil.

Devonian (Late: 350 Ma)

Embryophytes: vascular plant sporophytes with secondary thickening (i.e. woody), up to 18 m tall, with ‘roots’ going several m into rock/soil.

Archaeopteris (Progymnospermopsida) the first ‘modern’ tree. (Not to be confused with *Archaeopteryx*).

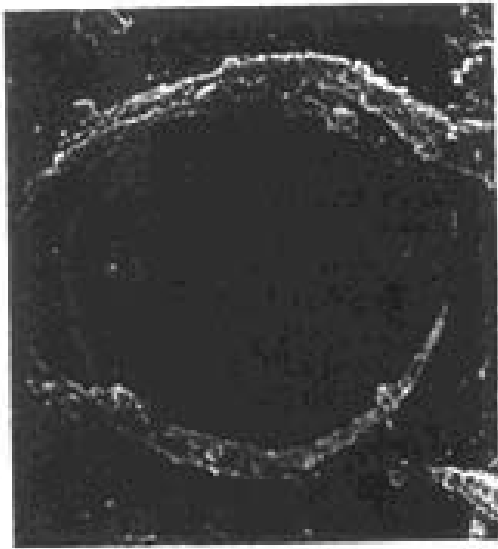

12.13



12.14

Figure 12.13 Detail of pit membrane of *Callixylon*. $\times 5,400$. (From Beck et al., 1982).

Figure 12.14 Suggested reconstruction of *Archaeopteris*. (From Beck, 1962).

What were the Constraints on the Earliest Photolithotrophs on Land?

Implicit comparison with marine/freshwater biota:

- (1) Water vapour loss during CO₂ uptake from atmosphere.**
- (2) Increased incident UV flux**
- (3) Greater short-term extent of temperature changes.**

All shared to some extent by relatives in marine intertidal (but covered by high tide: need not photosynthesize when emersed), small bodies of freshwater.

Atmosphere as only source of CO₂ the dominant unique problem.

Cyanobacteria, green algae, earliest embryophytes on land were:

Poikilohydric, i.e. unable to control water loss to atmosphere;
path for water vapour loss to atmosphere necessary if CO₂ is to be
fixed;

Desiccation-tolerant, otherwise could not survive on land without
continuous rain/occult precipitation.

Both traits inherited from marine intertidal/shallow freshwater
ancestors.

Later embryophytes (Late Silurian: 400 Ma) at pteridophyte grade of organisation were **homoiohydric**, i.e. able to control water loss to atmosphere.

When water is available in soil, plant loses water vapour at atmosphere while taking up CO₂ (driving force and pathway for water vapour loss).

When water is not available in soil in sufficient amounts to satisfy evaporative demand of atmosphere, water vapour loss is restricted, so plant stays hydrated (at least for a while) but does not fix atmosphere CO₂.

Homoiohydric requirements include

Cuticle

Stomata

Intercellular gas spaces

Xylem (or its functional equivalent)

Roots (or their functional equivalent)

Homoiohydricity permits plants to grow in habitats with discontinuous water supply without being desiccation-tolerant in their vegetative state.

Vegetative desiccation toleration ('resurrection plant' habit) rare in extant tracheophyte sporophytes (commonest in pteridophyte grade; absent in conifers; very rare in dicotyledons).

Vegetative desiccation intolerance

Absent (for whatever reason) in plants more than 1m tall, so homoiohydricity was essential for development of a land flora containing plants 1-100m high.

Genes for desiccation tolerance very widespread:

Function in spores, seeds of many homoiohydric plants.

Homoiohydric characteristics permitted evolution of multilayered photosynthetic canopy by a plant with external area amplification ('leaves') and internal area amplification (intercellular gas spaces).

These two characteristics are not combined in any extant Poikilohydric plants (gametophytes or sporophytes).

Polytrichum, Dawsonia gametophytes:

Many layers of unistratose leaves and xylem-like water conducting tissue (hydrome) and cuticle.

Marchantia gametophytes: thallus with spores, intercellular gas spaces.

Costs of Homoiohydric

Xylem + cuticle + stomata + intercellular spaces comprise at least 8% of the dry matter of even the smallest homoiohydric organism (e.g., an *Arabidopsis* seedling).

Larger fraction of dry matter of larger homoiohydric organisms (e.g. trees) taken up by homoiohydric apparatus, mainly xylem (but difficult to tease out conducting from mechanical roles).

Costs of Vegetative Desiccation Tolerance

Desiccation tolerance found in most poikilohydric truly plants (i.e., those in environments without a continuous supply of water on substrate surface). Costs (if any) not well-defined. Genes related to desiccation tolerance of propagules widespread in vascular plants.

Benefits of Homoiohydric (apart from regulated water content)

Productivity of 'best-performing' homoiohydric plants greatly exceeds that of 'best-performing' terrestrial poikilohydric plants when both are grown under optimal conditions in today's atmosphere.

Tendency for plants to grow taller (resources and habitat stability permitting) in relation to

(1) Light interception

(2) Spore dispersal into turbulent air

How did the Early Terrestrial Vascular Plants Modify the Global Environment?

CO₂ Drawdown:

10-fold in atmospheric CO₂ the Devonian.

(1) Conversion of atmospheric CO₂ to organic C on land surface.

Not major cause of drawdown: quantity and (especially) lifetime.

(2) Weathering of silicates. Exploitation of little-weathered surfaces by vascular plants with deeper roots; (some weathering by pre-vascular land biota meant that vascular plants were not necessarily moving onto pure rock).

Weathering of silicates removes CO_2 from atmosphere;
Increases alkalinity of surface ocean (until precipitated as $\text{CaCO}_3/\text{MgCO}_3$).

Weathering of CaCO_3 , MgCO_3 from land surface consumes CO_2 :

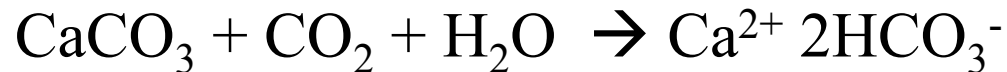

but the CO_2 is re-released upon CaCO_3 precipitation in the ocean:



Plant Nutrient Supply

Weathering and soil development release plant nutrients such as K^+ , $H_2PO_4^-$, SO_4^{2-} , Ca^{2+} , Mg^{2+} from rocks; some release of (chelated) Fe^{3+} .

No N made available; more of the other nutrients, more biomass, larger shortfall of N supply from lightning as NO_x . Selection for more N_2 fixation by free-living and (?) symbiotic organisms (no evidence from fossils till Triassic).

Hydrological Cycle

Vegetation cover, soil, moderate run-off by adding 'capacitance' and 'resistance'. Increase water vapour loss from land surface by keeping water in soil, providing conduits to an evaporating surface which absorbs solar energy and provides latent heat of evaporation in the form of plants.

CO₂ drawdown

Increased water cost of photosynthetic CO₂ acquisition from atmosphere as CO₂ content of atmosphere decreased.

Potential photosynthetic rate on plant area basis maintained by increase in stomatal density from Silurian/Early Devonian to late Devonian/Carboniferous (Chaloner, McElwain, Berrling).

TODAY

Net Primary
Productivity
(Pmol C y⁻¹)

Total Habitat
Area (m²)

Biota

Marine Phytoplankton

4

370.10¹²

Terrestrial

5

150.10¹²

- (1) Probably photosynthetic primary producers on land from 1.2 Ga; significant fraction of present-day primary productivity by 450Ma; plants more than 1 m high by 410 Ma.
- (2) Earliest primary producers on land were cyanobacteria and green algae; embryophytes evolved from Charophycean green algae by 440 Ma; vascular plants by 420 Ma.
- (3) Constraints of life on land were evaporative water loss from plants obtaining CO₂ from atmosphere, increased variability of temperature, increased UV. All three faced to some extent by earlier photolithotrophs in the marine intertidal and in small bodies of freshwater.
- (4) Earliest land photosynthesizers faced the CO₂/water/problem by poikilohydry/desiccation tolerance; later, larger dominant photosynthesizers homoiohydric/desiccation intolerant. Costs and benefits of homoiohydry.

- (5) Early vascular plants modified global environment by CO₂ drawdown (mainly by weathering); changed hydrology and increased nutrient availability on land.
- (6) CO₂ drawdown led to increased water cost of growth (helped increased water storage in soil), increased stomatal density (maintain productivity), evolution of planar photosynthetic structures, vegetative, abscission, recycling of nutrients.
- (7) Marine global productivity equalled by terrestrial in Carboniferous?

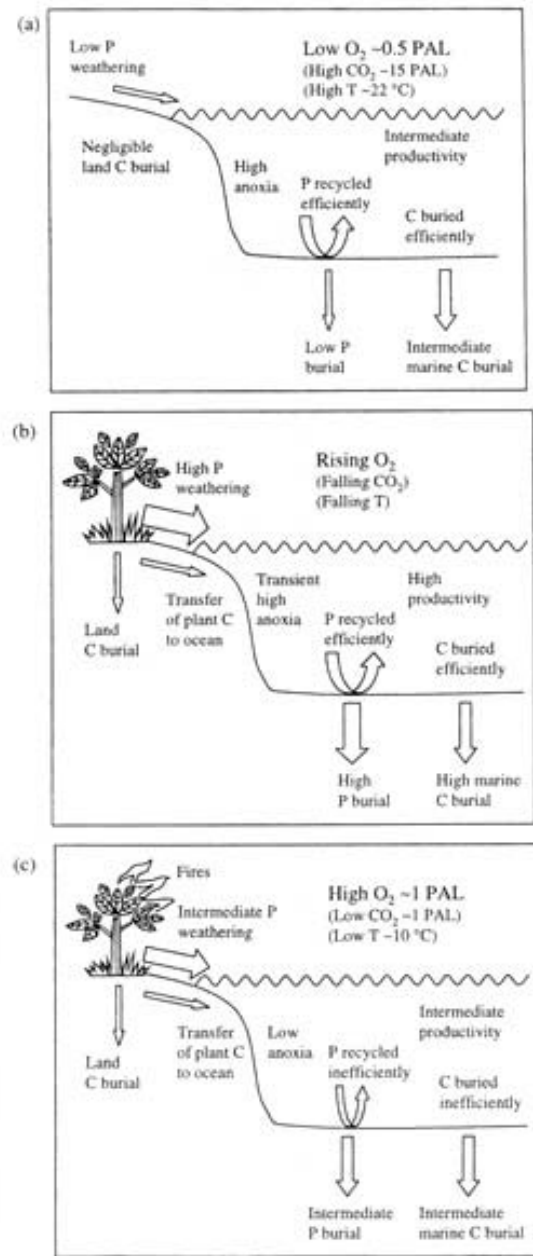

Fig. 2 Postulated changes in phosphorus cycling, organic carbon burial and atmospheric oxygen resulting from the rise of land plants: (a) preplant state, (b) transient behaviour, and (c) new state with plants. (PAL, present atmospheric level in atm.) Changes in atmospheric CO_2 and temperature are those predicted by Berner (1994).

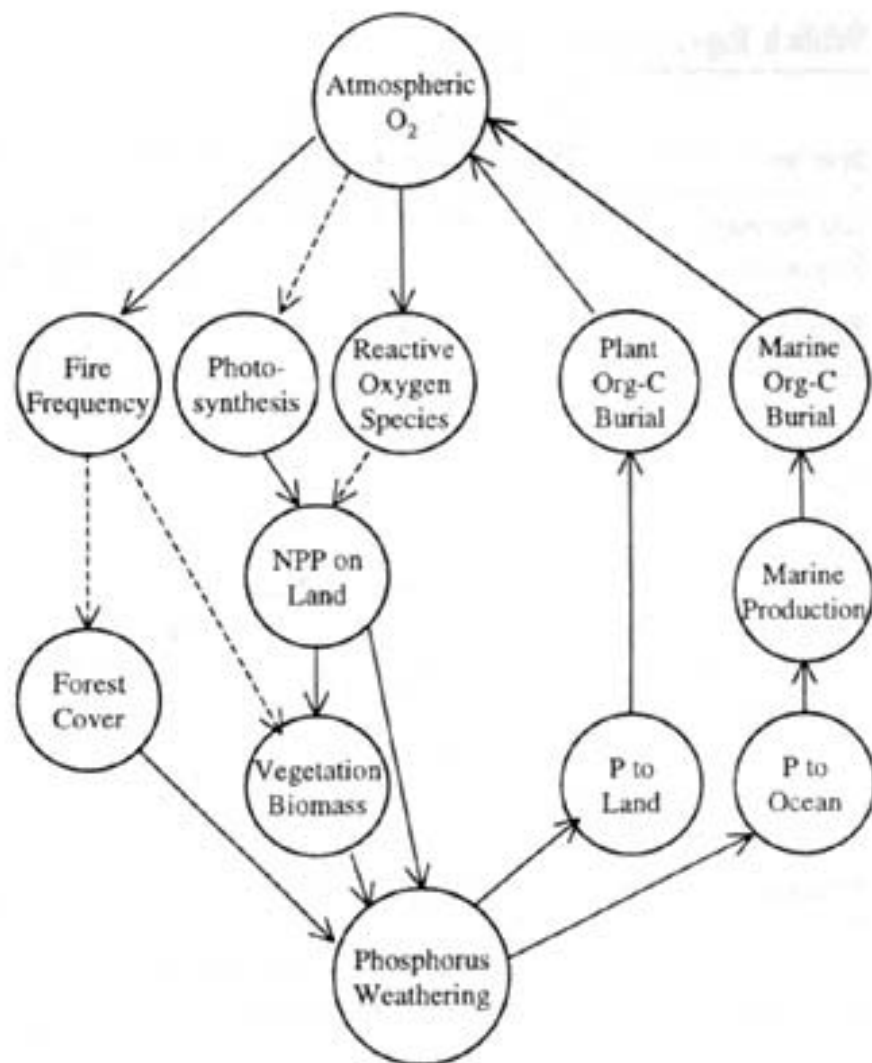
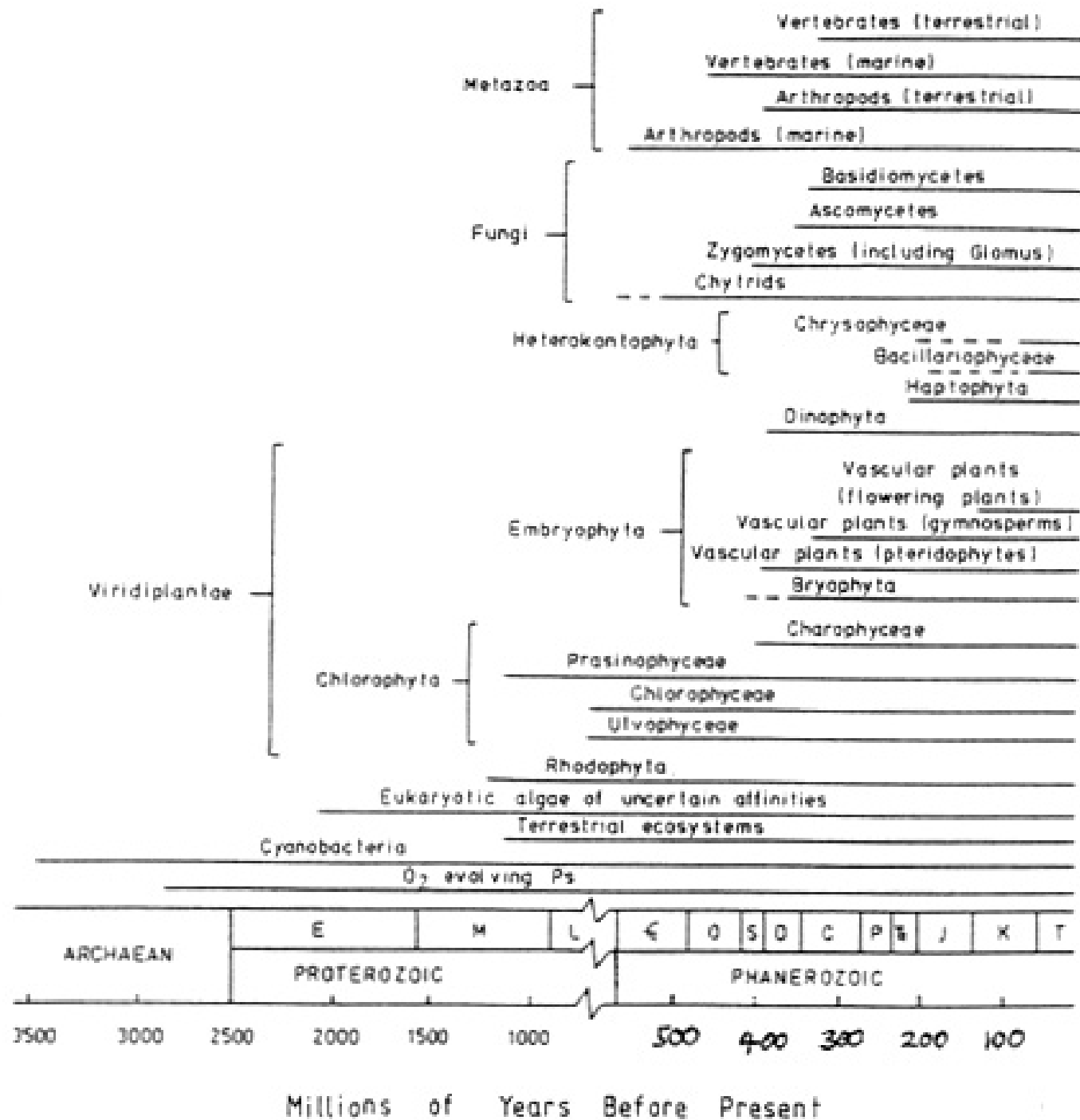
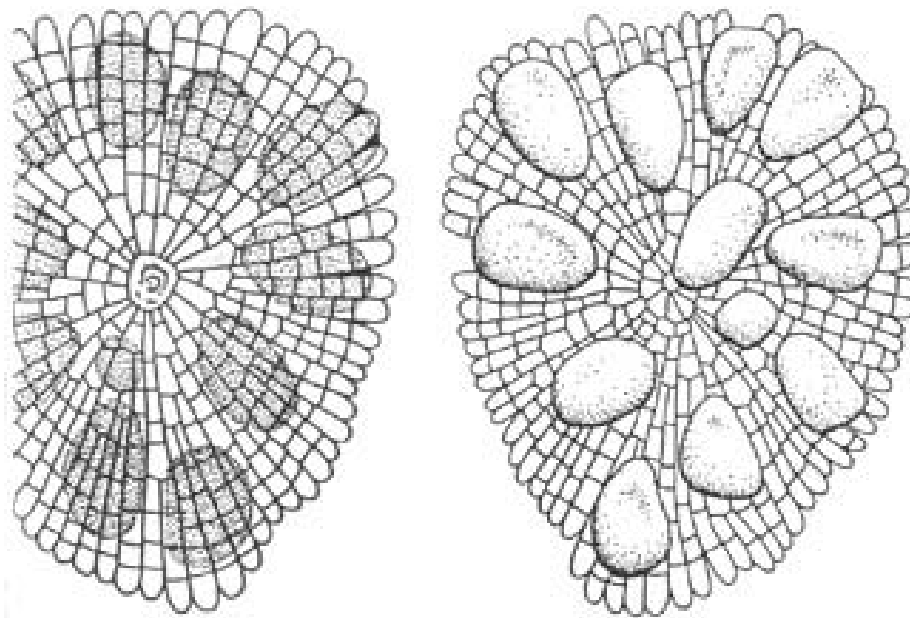
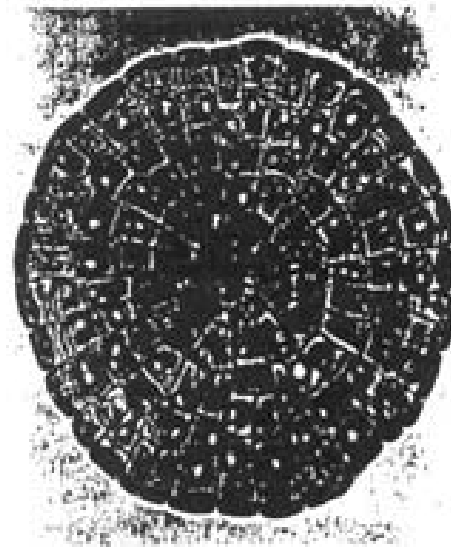

Fig. 3 Hypothesized oxygen regulator involving land plants and their amplification effect on phosphorus weathering (H8). Bold arrows indicate a direct relationship (e.g. increasing O_2 increases fire frequency). Dashed arrows indicate an inverse relationship (e.g. increasing fire frequency decreases forest cover). Negative feedback loops, which have an odd number of inverse relationships, can be traced around the diagram.





.17 Suggested reconstruction of *Parka decipiens* showing upper (right) and lower surfaces.



-6. *Coleochaete orbicularis* illustrates radially organized, thalloid morphology is also characteristic of *C. scurata*. These species somewhat resemble early, radially red stages in development of gametophytes of the primitive moss *Sphagnum*.

Figure 21.4. A. Highly magnified transverse section secondary wood of *Callixylon newberryi* showing ray tracheids (rt). B. Radial section, secondary wood of *C. newberryi* showing grouped pitting. A,B: Upper Devonian. (A,B from Beck, 1970.)



Taxonomic distribution of tolerance of desiccation in the vegetative state in extant plants. All plants but those indicated as HOMIOHYDRIC are poikilohydric.

Tolerance of desiccation in the vegetative state	Aquatic plants	Ectohydric terrestrial plants	Endohydric terrestrial plants
Intolerant	Many algae (primarily aquatic plants) and pteridophytes (secondarily aquatic plants) which normally live fully submerged.	Many bryophyte and pteridophyte gametophytes of moist habitats; many bryophyte sporophytes.	Almost all sporophytes of vascular plants (except resurrection plants listed below) [HOMIOHYDRIC]. Some bryophyte gametophytes (?).
Tolerant	Many algae which are regularly exposed to air (intertidal; shallow stream; vernal pools) (e.g. <i>Peruvia</i> spp.; <i>Chara</i> spp. phase of <i>Batrachospermales</i>).	Most lichens; many bryophytes.	Sporophytes of a small fraction of vascular plants 'resurrection plants', all less than a metre or so in height (~10% of species of pteridophytes, 0.1% of monocotyledons, 0.01% of dicotyledons, 0% of gymnosperms) [HOMIOHYDRIC].

Definitions

Desiccation-intolerant: killed if the water content of the organism equilibrates with 'dry' air ($\leq 70\%$ relative humidity, equivalent to about -48 MPa water potential).

Desiccation-tolerant: able to survive equilibration of the water content of the organism with 'dry' air; very few plants (some green algae and green algal lichens) can grow under such conditions.

Ectohydric: water supply to the transpiring surface via mass flow over the outside of a terrestrial plant.

Endohydric: water supply to the transpiring surface via the inside of a terrestrial plant, involving mass flow in the lumina of dead hydrome (bryophytes) or xylem (tracheophytes) cells.

Homiohydric: able to regulate water content (to varying extents in different plants) independently of supply from soil and 'evaporative demand' of the atmosphere.

Poikilohydric: water energy status (and hence water content) of the plant tracking with varying delays that of the environment.

Upper leaf surface of the moss *Dawsonia superba* Grev.

This moss is unusual in having leaves many cells thick. The comparatively complex leaf anatomy is very similar to *Polytrichum*, which is illustrated in many texts. There is a large lower epidermis and internal to this are several layers of cells, including groups of small thick-walled ones. The upper part of the leaf comprises a layer of large cells from which arise plates of cells. These plates of photosynthetic tissue extend along the length of the upper surface. Each plate is one cell wide and up to six cells high. The plates are shown in surface view in Plate 40. Air is able to diffuse freely between the plates and such an arrangement of photosynthetic tissue is somewhat analogous to that of *Marchantia* (Plate 32).

Plate 41 shows a closer view of part of three plates. The surfaces are covered with flakes of wax, which conceal the boundaries between the cells along the surface of each plate. To our knowledge, this is the first report of surface wax deposits on the leaf of a moss. We observed similar wax deposits on leaves of *Polytrichum juniperinum* Hedw. The families Polytrichaceae and Dawsoniaceae have many features in common, including the same chromosome number of $n = 7$ (Watson, 1971).

Plate 40

X 900

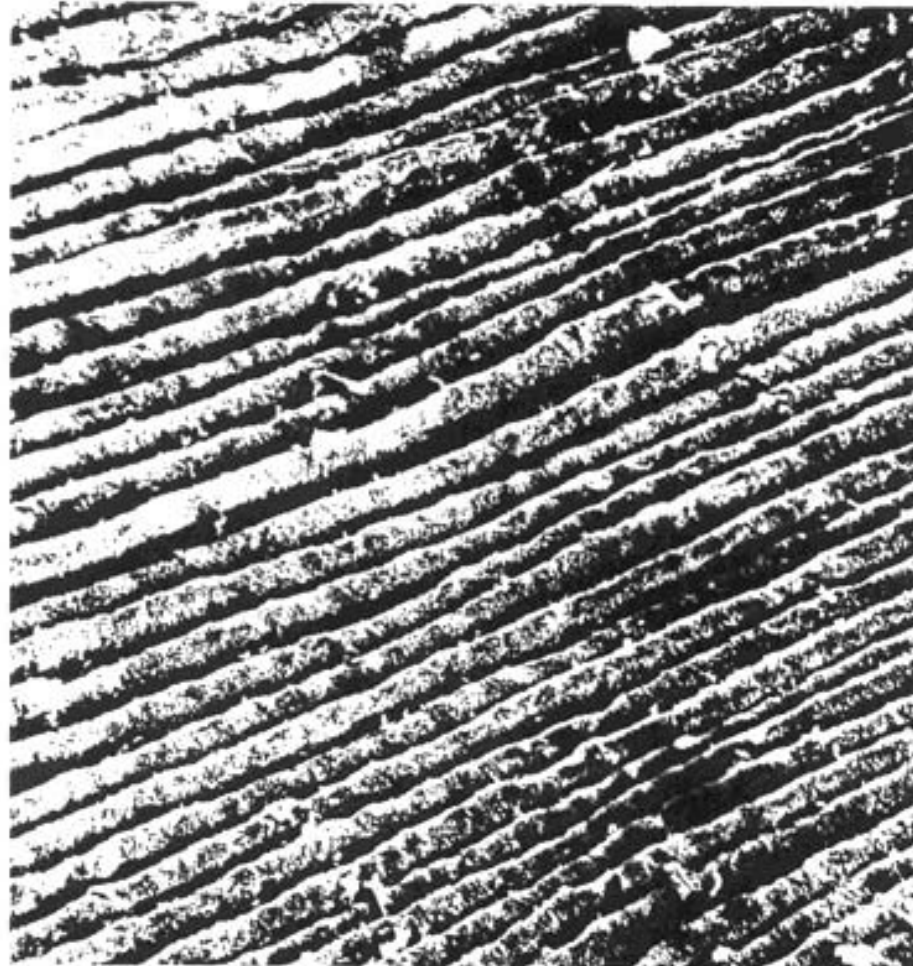

PHOTOSYNTHETIC RATES ON A GROUND AREA BASIS
FOR EXTANT O₂ EVOLVERS

Rates apply to 35Pa CO₂ and optimal hydration, light and temperate conditions.

Organism (and phase of life cycle and organ when appropriate)	Net photosynthetic rate (μmol CO ₂ m ⁻² s ⁻¹)	
Mat of filamentous cyanobacteria	0.9*	} No organised intercellular gas spaces or multilayer structure
Cryptoendolithic crust of unicellular cyanobacteria and unicellular green algae	1.1*	
Epiphytic green unicellular algae (>1 layer of cells)	3.8*	
Epilithic green algae with a flat unistratose thallus	3.3*	
Thalloid liverwort lacking intracellular gas spaces (gametophyte)	0.8	} No intercellular gas spaces; multilayer structure
Moss shoot with ten layers of unistratose leaves (gametophytes)	<0	
Thalloid liverwort with intercellular gas spaces (gametophyte)	3.6	} Intercellular gas spaces; no multilayer structure
Crustose lichens with intercellular gas spaces	4.7*	
Fruticose lichens with intercellular gas spaces	<15.1	
C ₃ leaf with intercellular gas spaces (sporophyte)	34 [†]	} Intercellular gas spaces and multilayer structure
C ₄ leaf with intercellular gas spaces (sporophytes)	51 [‡]	

- * = organisms with 'CO₂ pump'
- * = organisms some of which have a 'CO₂ pump'
- † = usually several leaf layers, so whole plant rates may be twice or more these 'single leaf' values

others have purely diffusive CO₂ entry

From a table in Raven, J.A. (1996). 'The early evolution of land plants: aquatic ancestors and atmospheric interactions'. *Botanical Journal of Scotland* 47, 151-175.

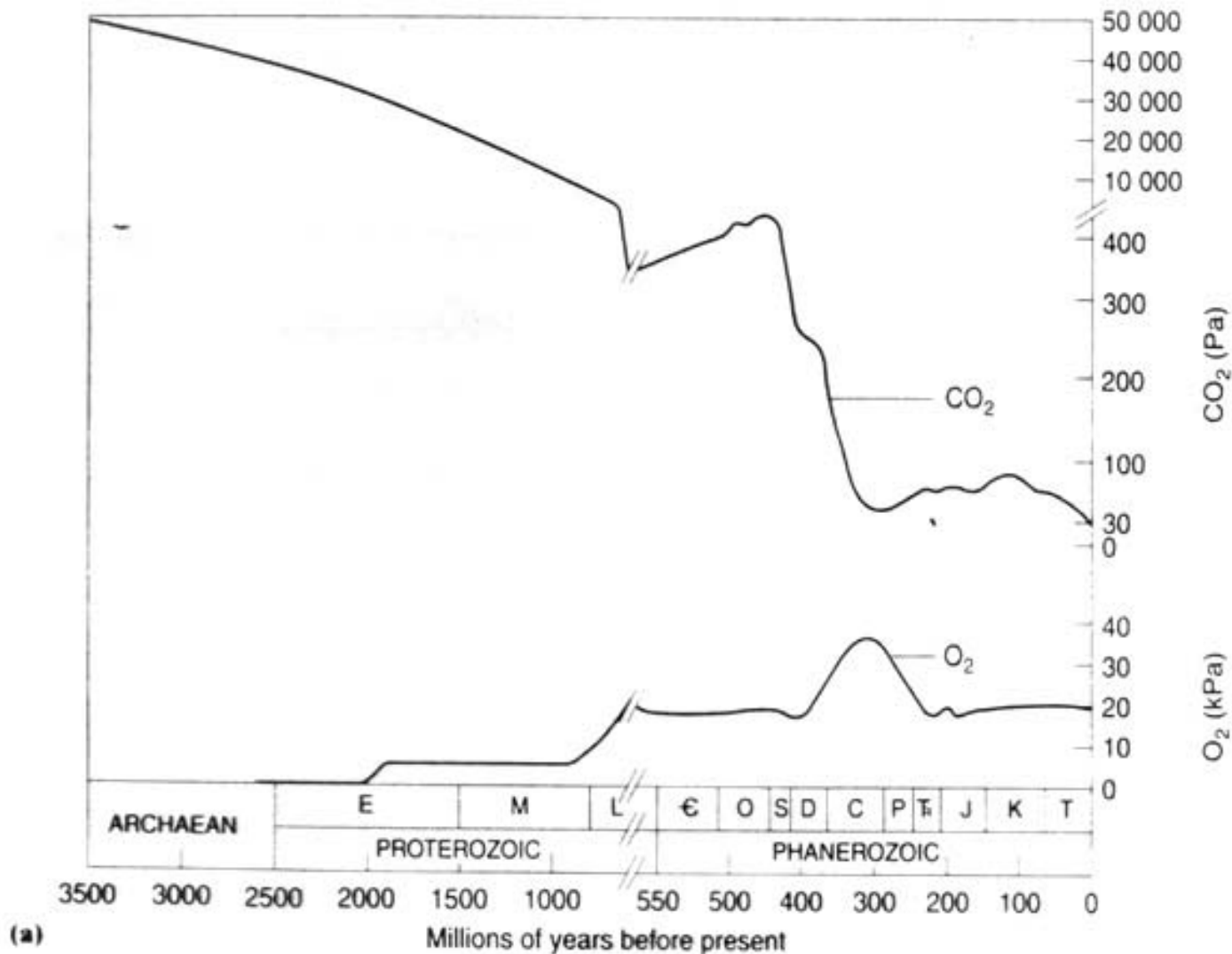
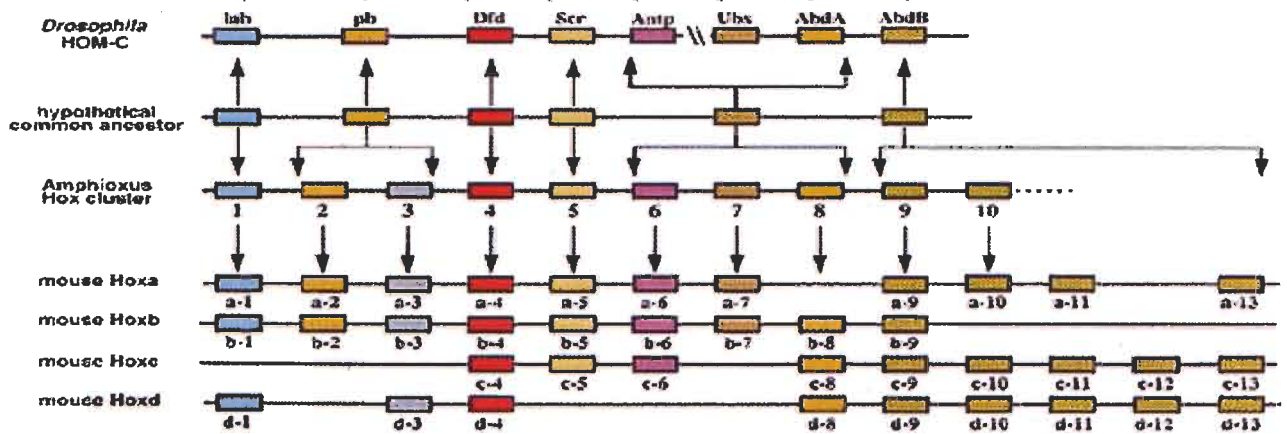

Figure 1.4 (a) A reconstruction of variations in the partial pressures of CO₂ and O₂ in the atmosphere through geological time using data from Berner (1990, 1993) and Berner and Canfield (1989) for the post-Cambrian epochs (i.e., the Phanerozoic). The absolute values and timing for the evolution of oxygen are not constrained in the Proterozoic epoch.

DROSOPHILA EMBRYO

HEAD THORAX ABDOMEN



MOUSE EMBRYO

